

Multi-Hopper Grinders

A superior coffee grinding system combines the ability to grind multiple coffees with patented BrewWISE® Technology

Grinders



MHG
(Black)
(funnel sold separately)



MHG
(Stainless)

PRODUCT FEATURES

- Convenient, front-loading hoppers allow grinding of a wide variety of coffees.
- Hoppers hold up to 2.75 kg each of regular, decaf or speciality beans.
- Stores individual coffee grind weight profiles.
- Portion controlled for the right amount of coffee, with three batch sizes per hopper.
- Precision burrs for consistent, commercial quality grind.
- Easy-to-clean removable hoppers.
- LCD alphanumeric display shows coffee names and diagnostics.
- Accommodates all BrewWISE® Smart Funnels®.
- BrewWISE® intelligence means the Smart Hopper manages the grinding and brewing process from start to finish.
- Smart Hopper tells the grinder what coffee is in it through a microchip in the hopper.

RELATED PRODUCTS



2 Position Rack
Product No.: 36760.0000



4 Position Rack
Product No.: 36760.0001



Hopper/Lid Assembly
Product No.: 36845.0000

Hopper Partition
Product No.: 36053.0000



BrewWISE Recipe Writer



BrewWISE Recipe Card

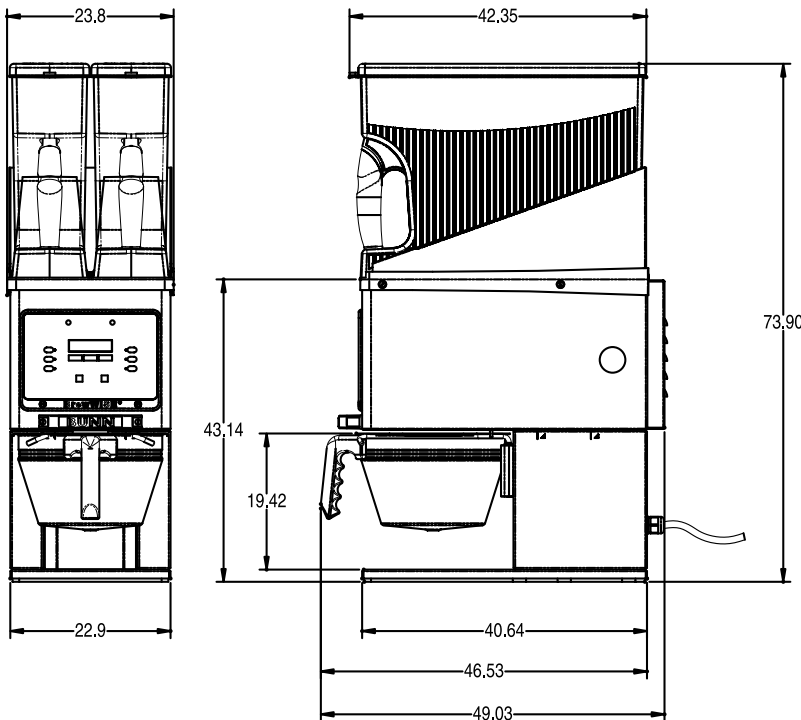

Multi-Hopper Grinders

Product #	Description	Shipping Weight	Electrical					Cord	Agency
			Volts	Amps	Watts	Hertz	Phase		
35600.0001	MHGA	31.8 kg	230	4.5	1035	50	1	Yes	
35600.0003	MHGA, black		230	4.5	1035	50			
35600.0005	MHGB		100	9	900	50			
35600.0008	MHGB					60			

Dimensions in centimetres. Other models may be available, please contact your BUNN Sales Representative. For capacities, additional specs, manuals, care & cleaning, visit www.bunn.com.

Portion Control Grinders with 1 Hopper



G9T HD, Tall
(funnel sold separately)

PRODUCT FEATURES

- Single hopper holds 4.1 kg of coffee.
- Portion controlled for the right amount of coffee every time.
- Precision burrs for consistent, commercial-quality grind.
- Three-year warranty on grinding burrs.
- Accommodates larger brewer funnels.

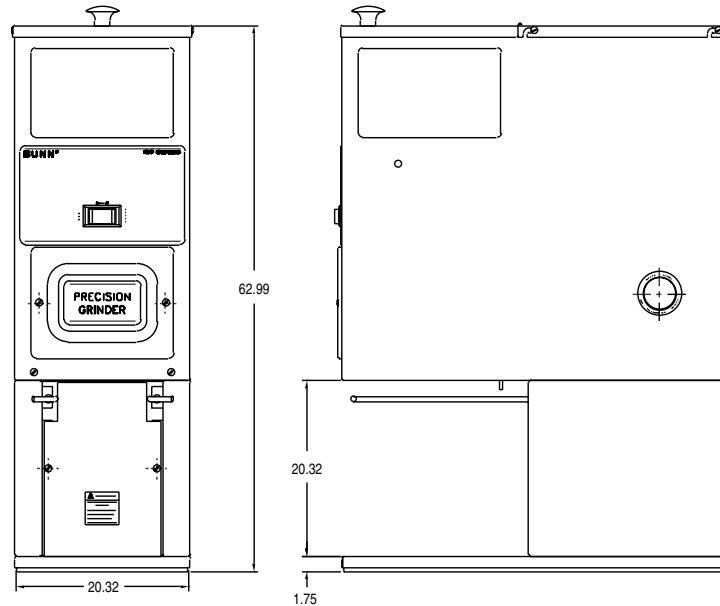

G9T HD, Tall

Portion Control Grinders with 1 Hopper

Product #	Description	Shipping Weight	Electrical					Cord	Agency
			Volts	Amps	Watts	Hertz	Phase		
05800.0023	G9TA HD, tall	39.5 kg	230	4.5	1035	50	1	Yes	CE

Portion Control Grinders with 2 Hoppers



G9-2T
(funnel sold separately)



G9-2T DBC
(funnel sold separately)

PORTION CONTROL GRINDER

(G9-2T on left)

- Two hoppers hold 2.7 kg each.
- Selected models interface to compatible BUNN brewers with interface cable.
- Portion controlled for the right amount of coffee every time.
- Precision burrs for consistent, commercial-quality grind.

BREWWISE® DBC GRINDER

(G9-2T DBC on right)

- Two hoppers hold 2.7 kg each.
- Stores individual coffee grind profiles.
- Operate any combination of BrewWISE® equipment error-free with wireless brewer-grinder interface via Smart Funnel®.
- Portion controlled for the right amount of coffee every time with 3 batch sizes per hopper.

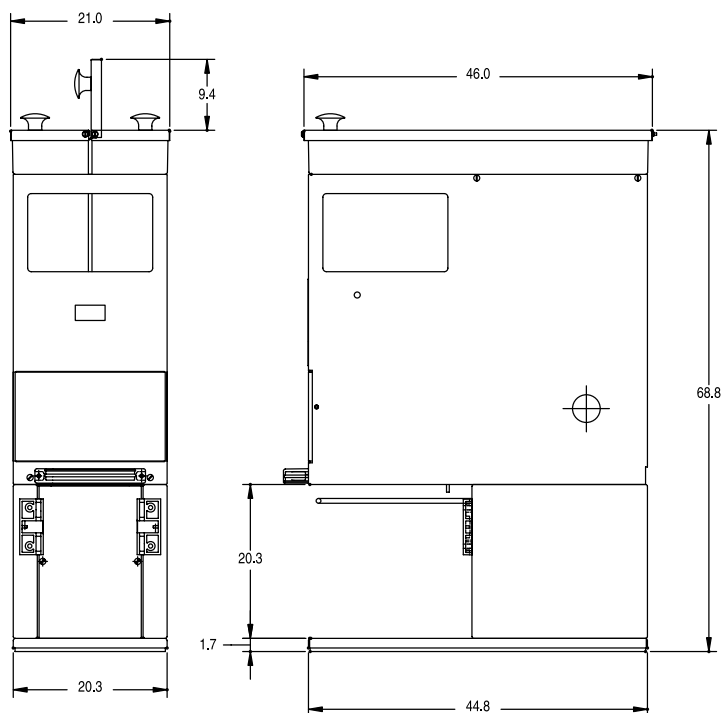

Portion Control Grinders with 2 Hoppers

Product #	Description	Shipping Weight	Electrical					Cord	Agency
			Volts	Amps	Watts	Hertz	Phase		
24250.0022	G9-2TA HD, interface	32.2 kg	230	4.5	1035	50	1	Yes	CE
33700.0005	G9-2TA DBC	30.4 kg	230	4.5	1035	50		No	
33700.0007	G9-2TB DBC		100	9.4	940				
33700.0009	G9-2TA DBC, black		230	4.5	1035		CE		

Low Profile Portion Control Grinders



LPG
(funnel sold separately)



LPG-2E
(funnel sold separately)

PRODUCT FEATURES

- Professional grind provided by large 81mm diameter burrs.
- Powered by quiet, high-torque motor.
- Large, clear bean hopper merchandises 2.75 kg of fresh coffee beans.

LPG-2 FEATURES

- Two 1.36 kg hoppers allow for regular and decaf or speciality beans.

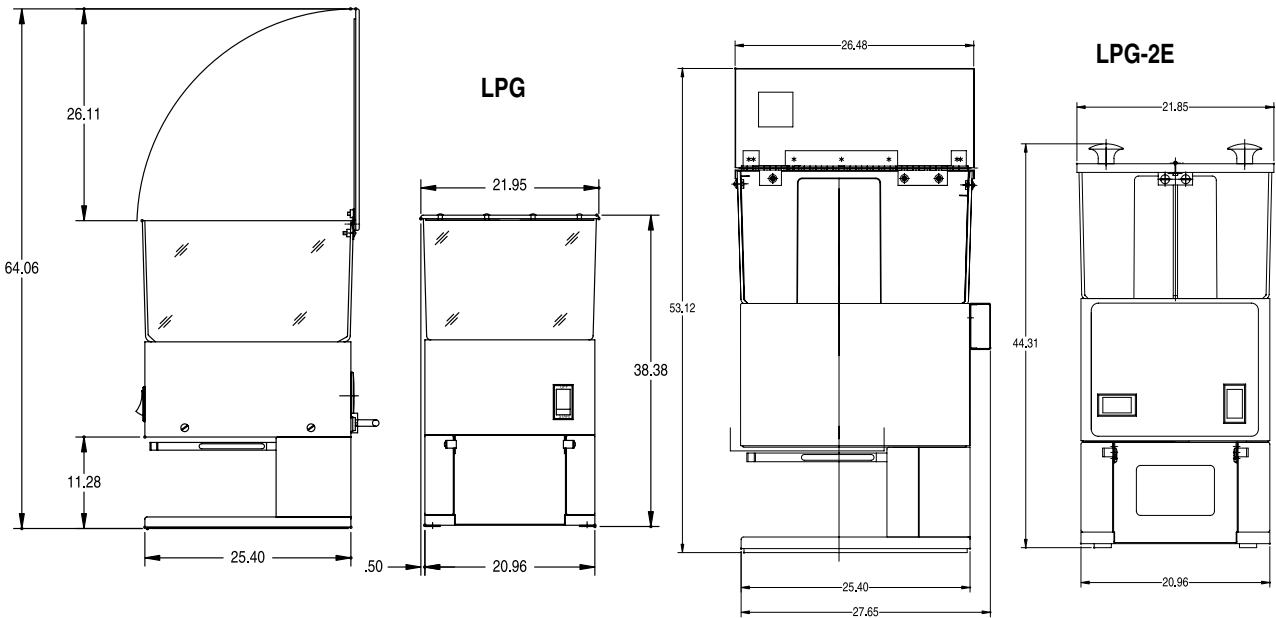

Low Profile Portion Control Grinders

Product #	Description	Shipping Weight	Electrical					Cord	Agency
			Volts	Amps	Watts	Hertz	Phase		
20580.0005	LPG	10 kg	100	4	400	50	Yes		
20580.0006	LPGA	10.4 kg	230	1.5	360	50/60		CE	
20580.0014	LPGA	10.5 kg	220-230					CE	
26800.0004	LPGA-2E	12.5 kg	220-230					CE	

French Press Portion Control Grinders



FPG
(funnel sold separately)



FPG-2 DBC
(cafetiere not available)

PRODUCT FEATURES

- Accommodates up to 20.3 cm tall cafetiere or funnel for drip-style brewer.
- Multi-batch setting allows users to specify a French press brew size or grind enough coffee into a funnel to brew up to 3.0 litres of drip-style coffee.
- Single hopper holds 2.72 kg of beans.
- Two hoppers hold 1.36 kg each of beans.
- Large commercial 81 mm diameter burrs provide maximum grinding precision for small amounts of coffee.
- Quiet, low speed, high torque motor.
- Digital touch pad for front of machine programming and LCD readout (FPG-2 DBC)
- Can accommodate gourmet funnel for heavier throw weights.

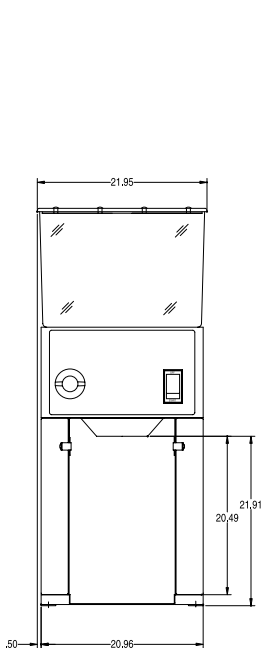

FPG

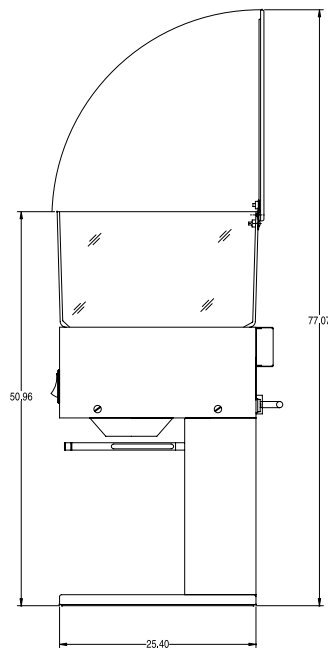

FPG-2 DBC

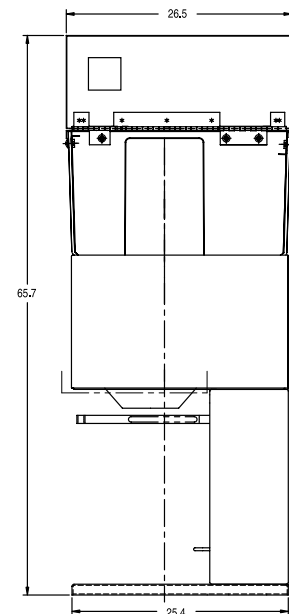
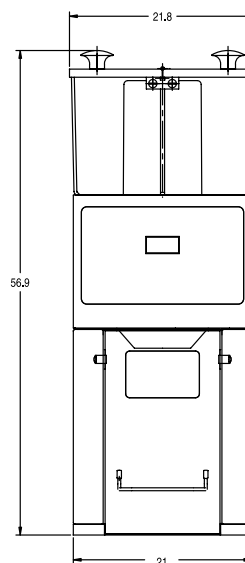

French Press Portion Control Grinders

Product #	Description	Shipping Weight	Electrical					Cord	Agency
			Volts	Amps	Watts	Hertz	Phase		
36800.0001	FPGA, black	13.4 kg	230	1.5	360	50/60	1	Yes	CE
36800.0002	FPGA					60			
36800.0004	FPGA, SST		50						
36400.0002	FPG-2 DBC		100	3.6	230	1.5	50		CE
36400.0003	FPGA-2 DBC								

Bulk Coffee Grinders



G2 HD

G3 HD

PRODUCT FEATURES

- G2 hopper holds .91 kg of fresh coffee beans.
- G3 hopper holds 1.36 kg of fresh coffee beans.
- Turbo action draws coffee through grind chamber for greater grinding efficiency.
- Fast grinding .45 kg in under 30 seconds.
- Wide range of grinds can be selected.
- Convenient cleaning lever ensures complete clean out of coffee from grind chamber.
- Bag switch stops motor when bag is removed and prevents grinding before bag is in place.
- Heavy-duty precision burrs for quality, finer grinds.

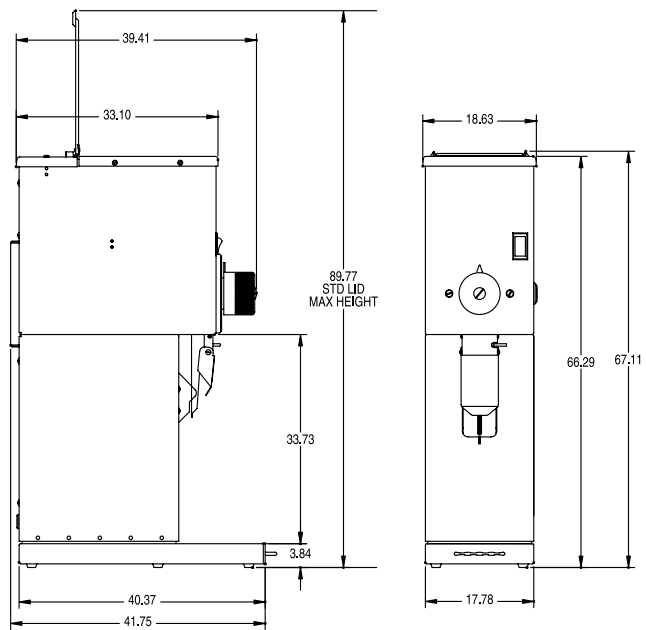

G2/G3 HD

Bulk Coffee Grinders

Product #	Description	Shipping Weight	Electrical					Cord	Agency
			Volts	Amps	Watts	Hertz	Phase		
22102.0005	G2A HD, Turkish burrs, black	27.7 kg	230	4.5	1035	50	1	Yes	CE
22100.0006	G3A HD, black	26.8 kg			990	60			
22100.0008	G3A HD, black		220	990	60	No			
22100.0013	G3A HD, black, Korea								